

Monet

MO711

1 & 3/4 Bowl Topmount Sink With Drainer



All dimensions in mm

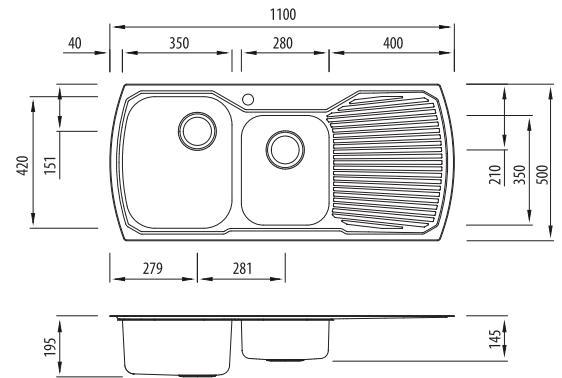

Specifications /

Sink size	1100W x 500H mm
Bowl size	Main Bowl 350W x 420H x 180D / 24L 3/4 Bowl 280W x 350H x 130D / 11L
Construction	2 piece, bowls and drainer seam welded
Material	304 grade, 18/10 polished stainless steel (0.8 mm thick)
Installation	Topmount
Fixings	Adjustable clips and sealing foam supplied
Min cabinet size	700 mm
Tap holes	1 tap hole only
Waste fittings	2 x 90 mm basket waste included
Overflow	Not available
Carton size	1267 x 567 x 237 mm
Weight	10 kg
Warranty	Lifetime manufacturer's warranty (refer to oliveri.com.au)
Maintenance and care instructions	All surfaces should be cleaned with mild liquid detergent or soap and water. To maintain the shine on your Oliveri stainless steel sink, we recommended the use of any of the easy to obtain, non-abrasive stainless steel cleaners or metal polishes.

Included accessories /

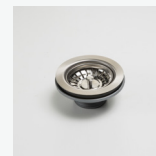

AC14
Basket Waste

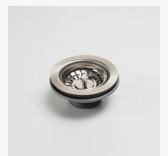

AC14
Basket Waste



AC74
Bamboo Board



AC7220
Colander