

Martini

Proudly Aussie made

All dimensions in mm

MR501

3/4 Bowl Topmount Sink With Drainer

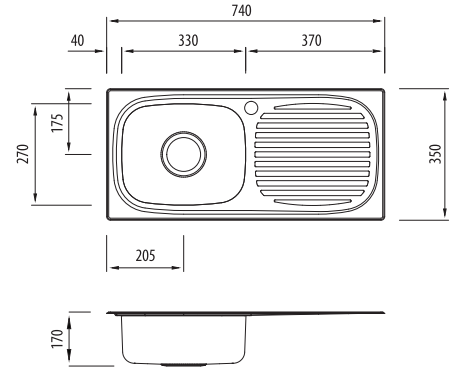

Specifications /

Sink size	740W x 350H mm
Bowl size	3/4 Bowl 330W x 270H x 155D / 12L
Construction	2 piece, bowls and drainer seam welded
Material	304 grade, 18/10 polished stainless steel (0.8 mm thick)
Installation	Topmount recommended
Fixings	Adjustable clips and sealing foam supplied
Min cabinet size	500 mm
Tap holes	Available 0 or 1 tap hole only (specify when ordering)
Waste fittings	1 x 90 mm basket waste included
Overflow	Not available
Carton size	757 x 367 x 182 mm
Weight	4 kg
Warranty	Lifetime manufacturer's warranty (refer to oliveri.com.au)
Maintenance and care instructions	All surfaces should be cleaned with mild liquid detergent or soap and water. To maintain the shine on your Oliveri stainless steel sink, we recommended the use of any of the easy to obtain, non-abrasive stainless steel cleaners or metal polishes.

Included accessories /

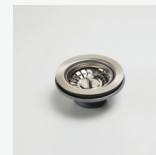

AC14
Basket Waste



AC02
Colander