

# Endeavour

Proudly Aussie made

All dimensions in mm

## EE21

Single Bowl Topmount Sink With Drainer

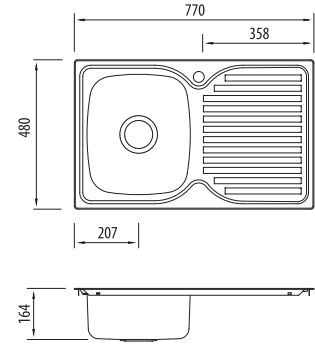

### Specifications /

<b>Sink size</b>	770W x 480H mm
<b>Bowl size</b>	Main Bowl 330W x 385H x 155D / 17L
<b>Construction</b>	2 piece, bowl and drainer seam welded
<b>Material</b>	304 grade, 18/10 polished stainless steel (0.8 mm thick)
<b>Installation</b>	Topmount
<b>Fixings</b>	Adjustable clips and sealing foam supplied
<b>Min cabinet size</b>	500 mm
<b>Tap holes</b>	1 tap hole (for no tap hole order product code "EE20")
<b>Waste fittings</b>	1 x 90 mm basket waste included
<b>Overflow</b>	Not available
<b>Carton size</b>	800 x 520 x 190 mm
<b>Weight</b>	5 kg
<b>Warranty</b>	Lifetime manufacturer's warranty (refer to <a href="http://oliveri.com.au">oliveri.com.au</a> )
<b>Maintenance and care instructions</b>	All surfaces should be cleaned with mild liquid detergent or soap and water. To maintain the shine on your Oliveri stainless steel sink, we recommended the use of any of the easy to obtain, non-abrasive stainless steel cleaners or metal polishes.

### Included accessories /

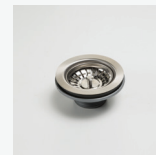

**AC14**  
Basket Waste