

Dublin

Proudly Aussie made

All dimensions in mm

DU1510

Inset Bath 1510mm With Tile Bead

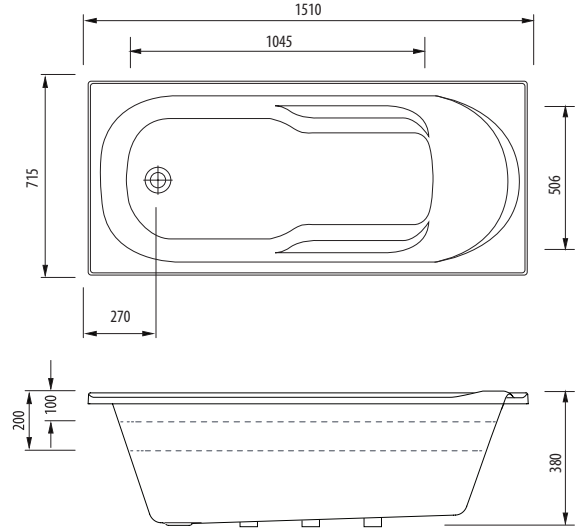

Specifications /

Construction	Moulded bath shell. Steel rod reinforced rim. Double reinforced bath base.
Material	Premium sanitary grade acrylic
Finish	High gloss
Colour	White
Waste outlet	Not included
Capacity	88 L
Installation	Built-in
Weight	15.1 kg
Dimensions	1510 W x 715 H x 380 D mm
Warranty	15 years replacement product, 1 year parts and labour (see Oliveri website for full details)
Maintenance and care instructions	All surfaces should be cleaned with mild liquid detergent or soap and water. Do not use cream cleaners or citrus based cleaning products, as they are abrasive. Use of unsuitable cleaning agents may damage the surface. Any damage caused in this way will not be covered by warranty.