

# Venice

## VE520MB-P

Matte Black Pull Out Goose Neck Mixer

All dimensions in mm

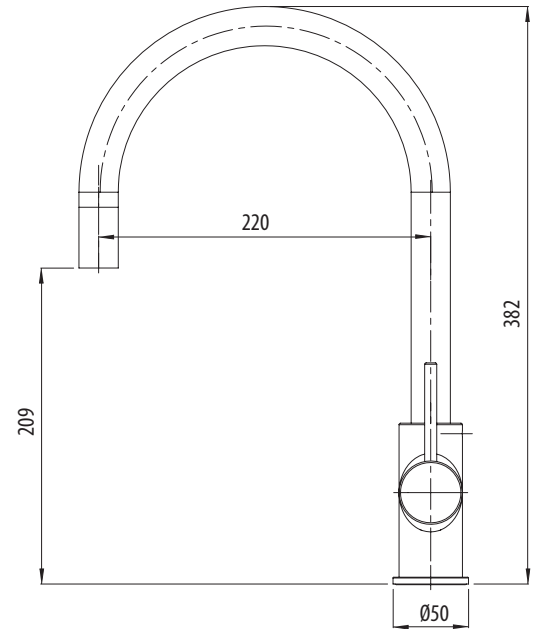

### Specifications /

<b>WELs rating</b>	5 Stars, 5.0 L per minute
<b>Temperature rating (min / max)</b>	1°C - 80°C
<b>Pressure rating (min / max)</b>	150 kPa - 500 kPa
<b>Finish</b>	Matte black (Electroplate)
<b>Materials</b>	Brass body (DZR low lead)
<b>Cartridge size</b>	35 mm
<b>Cartridge type</b>	Ceramic disc cartridge
<b>Carton size</b>	485 x 285 x 60 mm
<b>Product weight</b>	2.7 kg
<b>Mixer height</b>	382 mm
<b>Water supply</b>	Mains
<b>Warranty</b>	10 years (refer to <a href="http://oliveri.com.au">oliveri.com.au</a> for details)
<b>Maintenance and care instructions</b>	All surfaces should be cleaned with mild liquid detergent or soap and water. Do not use cream cleaners or citrus based cleaning products, as they are abrasive. Use of unsuitable cleaning agents may damage the surface. Any damage caused in this way will not be covered by warranty.