

Santorini

Italian made

All dimensions in mm

ST-MB1522 OF

Matte Black Single Bowl Topmount Sink With Drainer

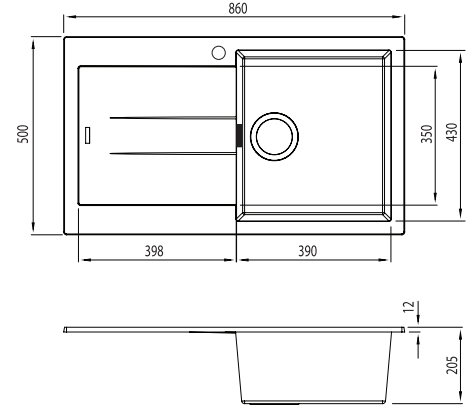
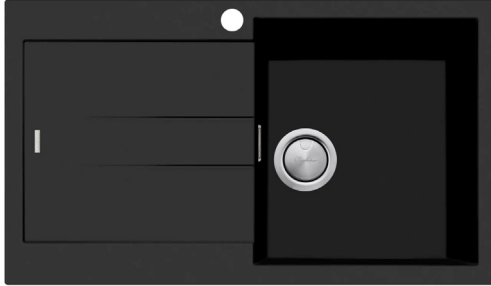

Overflow location

Specifications /

Sink size	860W x 500H mm
Bowl size	Main Bowl 2 390W x 430H x 200D / 34L
Construction	Moulded granite
Material	80% granite and quartz particles and 20% acrylic
Installation	Topmount
Fixings	Topmount clips supplied
Min cabinet size	500 mm
Tap holes	One tap hole only
Waste fittings	1 x 90 mm basket waste included
Overflow	Overflow kit included
Carton size	960 x 580 x 310 mm
Weight	15 kg
Warranty	Lifetime manufacturer's warranty (refer to Oliveri website)
Maintenance and care instructions	Clean the sink regularly with warm water, a liquid detergent and a soft cloth. Do not use abrasive powders or creams and avoid chemically aggressive detergents. Generic stains should be removed immediately with very hot water and a cleaning product. For organic stains which are especially difficult to remove, it is recommended that you fill the sink with a highly diluted organic cleaner such as bleach and let stand overnight. The next morning, rinse with warm water and a soft cloth.

Included accessories /

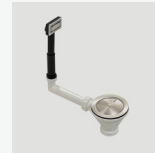

AC10
Basket Waste with
Rectangular Overflow