

Monet

MO71U

1 & 1/2 Bowl Undermount Sink



All dimensions in mm

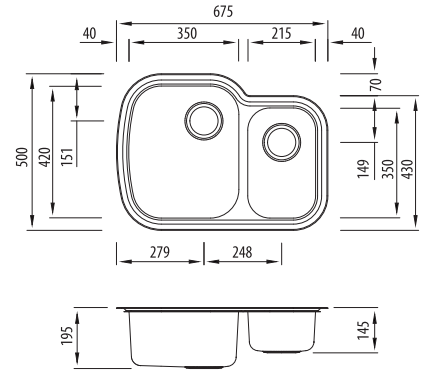

Specifications /

Sink size	675W x 500H mm
Bowl size	Main Bowl 350W x 420H x 180D / 24L 1/2 Bowl 215W x 350H x 130D / 9L
Construction	2 piece, bowls and rim seam welded
Material	304 grade, 18/10 polished stainless steel (0.8 mm thick)
Installation	Undermount
Fixings	Available on request
Min cabinet size	800 mm
Tap holes	N/A
Waste fittings	2 x 90 mm basket waste included
Overflow	Not available
Carton size	746 x 570 x 226 mm
Weight	7 kg
Warranty	Lifetime manufacturer's warranty (refer to oliveri.com.au)
Maintenance and care instructions	All surfaces should be cleaned with mild liquid detergent or soap and water. To maintain the shine on your Oliveri stainless steel sink, we recommended the use of any of the easy to obtain, non-abrasive stainless steel cleaners or metal polishes.

Included accessories /

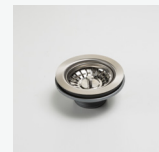

AC14
Basket Waste



AC14
Basket Waste



AC74
Bamboo Board



AC7220
Colander



AC7320
Utility Tray

